



恒鑫过滤
HengXin Filtration



湖州恒鑫过滤科技有限公司

Huzhou Hengxin Filter Technology Co.,Ltd

碳钢罐 不锈钢罐专用布水器/水帽
2020 (第十三期)



塑料水帽、布水器专业制造商/Filter Nozzles、Water distributor Manufacturer

湖州恒鑫过滤科技有限公司成立于一九九五年，是国内专业的水处理配件生产商，拥有各种国家专利四十余项，产品已出口美国、澳洲、欧洲、中东、台湾等多个国家和地区。

产品主要包括爪型布水器、玻璃钢罐体配件、水帽、盐阀及其配件，和具有自主知识产权的全塑精密过滤器（3芯/5芯/8芯/9芯）系列，全塑袋式过滤器（1#，2#）系列，玻璃钢精密过滤器（18芯）系列，大通量PALL款过滤器系列，TBF[®]管式可反洗过滤组件，大流量滤芯过滤器系统组合，以及具有大通量、高流速、高强度等优良性能的绕丝管布水器系列。

“以质量求生存，以诚信赢客户，以优新取市场”是恒鑫公司的创业宗旨。公司热忱欢迎您的光临和惠顾，期待您时刻关注我们的企业和产品。

Huzhou Hengxin Filter Technology Co.,ltd was found in 1995, is the professional manufacturer of water treatment products, have got more than 40 patent certifications. The Products have been exporting to America, Australia, Europe, Middle-east countries.

The main products including:water distributors,accessories of FRP tanks, filter nozzles,and UPVC cartridge filter housing (3/5/8/9 rounds) series, UPVC bag filter housing (1#/2#) series, FRP cartridge filter housing (18rounds) series. Pall filter housings, TBF[®] tubular Backwashing filters, High Flow Purification Systems,and high flow pvc sonic-welded screen water distributors.

With our good quality, profession & innovation products, excellent service, we warmly welcome your presence and patronage.



布水管, 水帽, 布水器

Filter Nozzle Arms, Filter Nozzles, Distributors

- ◎ 普通运用环境下 (砂滤罐、碳滤罐、多介质过滤器、软化罐、混床等过滤液为常温)

In normal application environment, The liquid of Sand filter tank, Carbon filter tank, Multimedia filter, Softening tank, Mixed bed is in normal temperature.

- ◆ 布水器 ◆ 布水管 ◆ 水帽
- Distributors, Filter Nozzle Arms, Filter Nozzles

- ◎ 特殊运用环境下 (处理液体为高温或酸碱液体, 有机溶剂等)

In special application environment, high temperature or Acid base liquid, organic solvent

- ◆ 布水器 ◆ 布水管 ◆ 水帽
- Distributors, Filter Nozzle Arms, Filter Nozzles



专业 创新

PROFESSION & INNOVATION



普通环境适用

Type: H173P



材质 (Material) : PP 缝隙 (Slots) : 0.2/0.5mm

Type: H60-5



Type: H60-10



Type: H42-16



备注: 可根据罐的大小定制, 任意缝隙可选。

Remarks: can be produced according to the size of the tank, slot can be chosen.

Type: H53-1, H53-2, H53-3

Type: H85

Type: H135

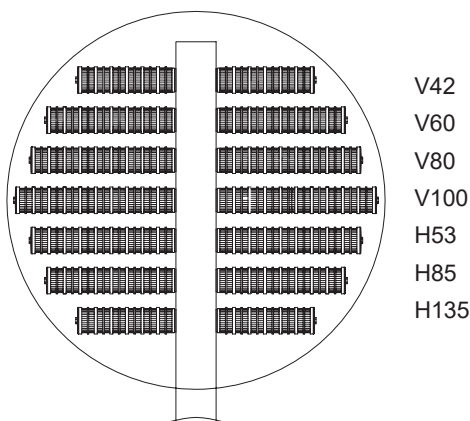
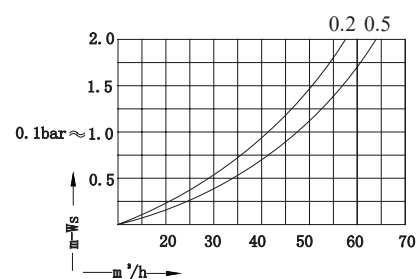
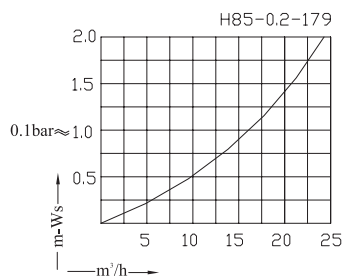
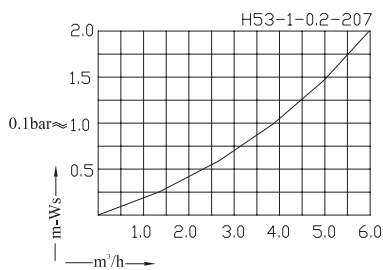
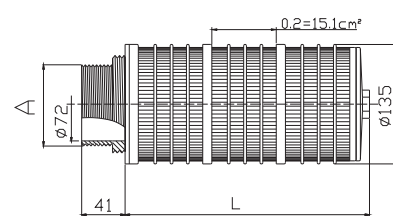
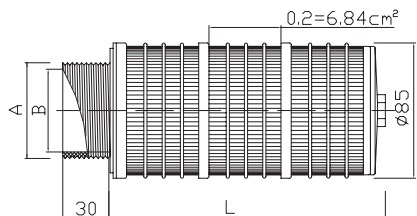
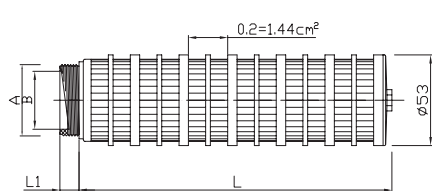
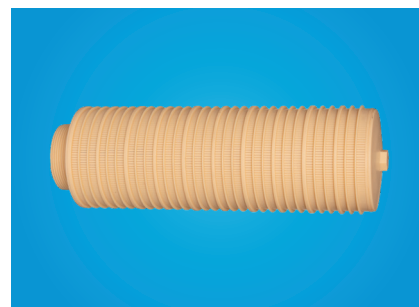

- V42
- V60
- V80
- V100
- H53
- H85
- H135

型号 (Type)	A(mm)	B(mm)	L1(mm)	缝隙Slots(mm)	材质Material	L2(mm)
H53-1	1/4"G	21	22	0.2/0.5	PP	207,271,303,335,+32...
H53-2	1"NPT/1"G	21	17			111,175,207,239, +32...
H53-3	3/4"NPT	18.5	17			111,175,207,239, +32...
H85	2"PT/2"NPT/2"G	50	30			73,126,179,232,285,+53...
	1.5"NPT/1.5"G	37	30			
H135	3"NPT/ 3"BSPT	72	41	173,248,323,398,473,+75..		

PVC全焊式绕丝筛管可广泛应用于油、气、水井防沙，化工，环保工业中，其在水处理工业中的地位尤其突出，是各类水资源及收集树脂过滤筛管中应用最广泛的一种。

PVC Sonic-welded screens can be widely used in the oil, gas, water wells sand prevention, chemical, environmental industries, the position in the water treatment industry is particular highlight.

产品优势:

1、该筛管由改性PVC材料研制而成，具有高强度，高韧性，耐酸碱，抗腐蚀等优点。

2、梯形丝持续绕组在呈圆周式排列的支撑杆上形成持续的高密度均匀缝隙，保证了筛管的开口面积百分比和无堵塞性，避免了沉淀物的高密度堆积造成的阻塞，从而为提高生产效率或延长设备的使用寿命提供了保证。

3、Vee字形开口的设计形式保证了液体过滤的顺畅性。

4、绕丝与所有纵向支撑杆之间均通过焊接组合，使整根筛管形成不可分割的整体，结实耐用，工作寿命周期更长久。

5、根据实际需求设计的纵向支撑杆排列，及筛管的连续性缝隙形式，使得该产品具备更高的抗压性能。

6、该成品的各项优秀性能提高了设备的过滤效率和使用周期，使得该产品成为液体过滤设备中佼佼者。

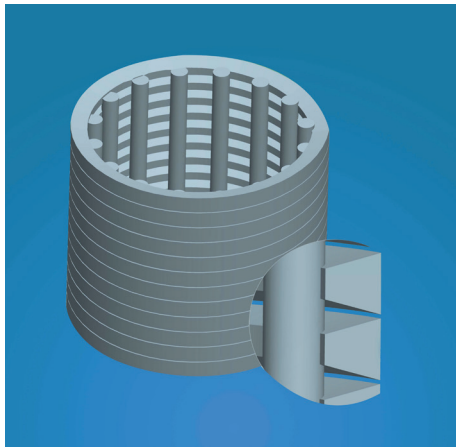

Product Merits:

1. UPVC Sonic-welded screen has good corrosion resistant from salts and gases commonly found in either salt or fresh water, more economical than metal screens.

2. The wedge wire wind around the cylindrical rod forms continuous, high-density uniform Vee shaped gaps, ensure the open area without blockage, and can avoid the accumulation of sediment caused by blocking high-density, so as to increase productivity or guarantee to extend the life of equipment.

3. The design of the Vee shaped gap ensures the liquid can be filter unobstructed.

4. The wedge wire and all the vertical rods are connected by sonic-weld. It's strong, durable, and has longer working life.

5. The design of the vertical rod arrangement can be changed according to the actual requirements; combine the continuous screen, making the product has a higher compression performance.

6. Its excellent performance improves the equipment's filter efficiency and the life cycle, makes it to become the leader in liquid equipment

型号	外径 O. D.	内径 I. D.	连接方式 Connect	缝隙 Slots (mm)	长度
V42	42mm	30mm	G3/4" / G1" / NPT1"	0.15/0.2/0.25/	自选 Optional
V60	60mm	46mm	G2" / NPT2"	0.3/0.35/0.4/	
V80	80mm	66mm	G3" / NPT3"	0.45/0.5/.....	
V100	100mm	86mm	G4" / NPT4"	任意缝隙可选	

本产品已获两项国家发明专利 专利号为:200710169538.8 和 200710164499.X

The product has got 2 patent certifications. The patent No.: 200710169538.8 200710164499.X

Type:H1201-A



材质 (Material) : PP/PVDF
 缝隙 (Slots) : 0.2mm

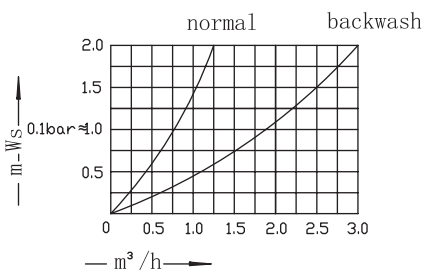

Type:H1201-B



材质 (Material) : PP
 缝隙 (Slots) : 0.2mm

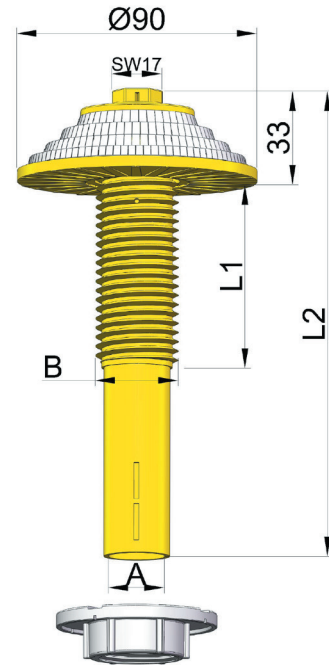
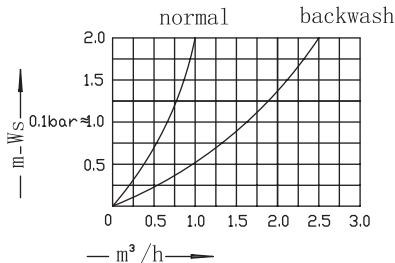

型号 (Type)	内径 A(mm)	外径 B(mm)	L1(mm)	L2(mm)
H1201-A	22	1¼WW	62	174
H1201-B	16	M24	62	174

注：用于砂滤器、双层滤器、多介质滤器、活性炭滤器等，内有调节流量球，如无需调节流量球，采购时请备注

Type: H1208



材质 (Material) : PP
 缝隙 (Slots) : 0.2mm

Type: H1208-1



材质 (Material) : PP
 缝隙 (Slots) : 0.2mm

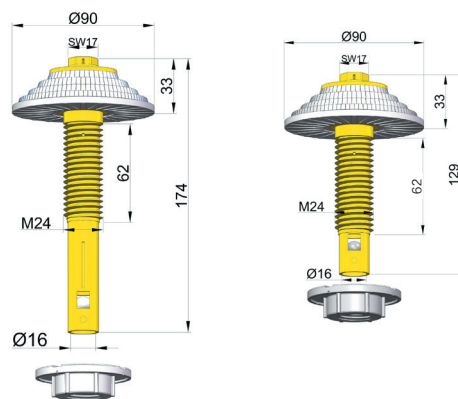

型号 (Type)	内径 A(mm)	外径 B(mm)	L1(mm)	L2(mm)
H1208	16	M24	62	174
H1208-1	16	M24	62	129

注：用于软水器、阳床、阴床和混床，内有调节流量球，如无需调节流量球，采购时请备注

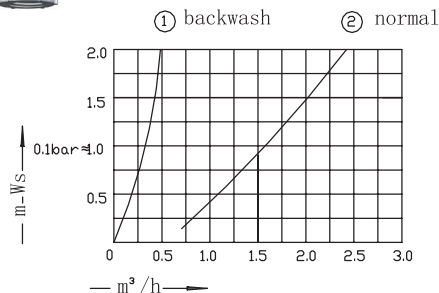

Type: H1202



材质 (Material): PP
 缝隙 (Slots): 0.2mm/0.35mm

Type: H1202-1



材质 (Material): PP
 缝隙 (Slots): 0.2mm/0.35mm

Type: H1202-3



材质 (Material): PP
 缝隙 (Slots): 0.2mm/0.35mm

Type: H1202-4



材质 (Material): PP
 缝隙 (Slots): 0.2mm/0.35mm

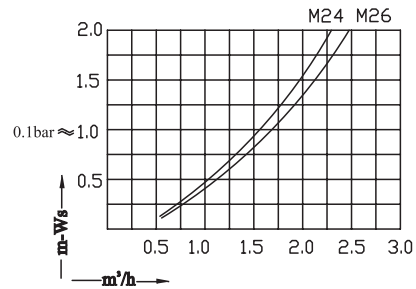
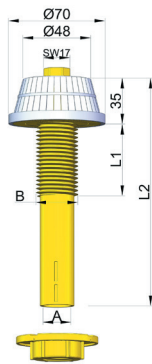

型号 (Type)	内径 A(mm)	外径 B(mm)	L1(mm)	L2(mm)
H1202	18/20	M24/M26	50	120
H1202-1	18/20	M24/M26	50	175
H1202-3	20	1¼WW	63	175
H1202-4	20	1¼WW	80	126

Type: H1201-C



材质 (Material): PP
 缝隙 (Slots): 0.2mm

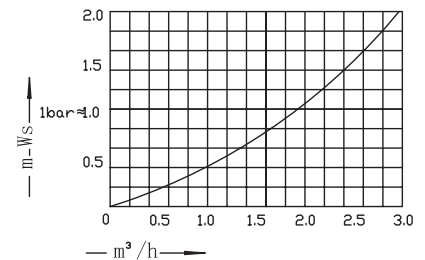
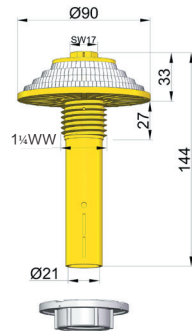

Type: H1203



材质 (Material): ABS
 缝隙 (Slots): 0.3mm

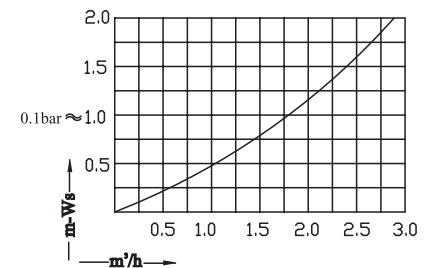
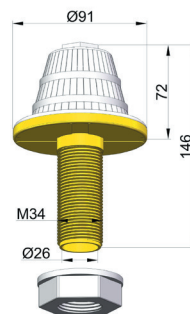

Type:H1205



材质 (Material) : PP
 缝隙 (Slots) : 0.2/0.5mm

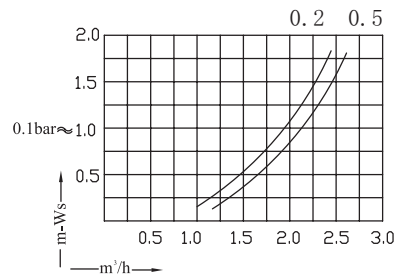
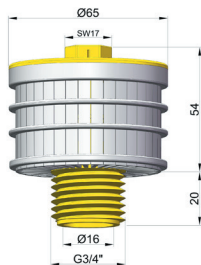

Type: H1206-A



材质 (Material): PP
 缝隙 (Slots): 0.2/0.5mm

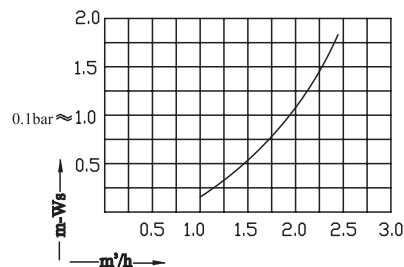
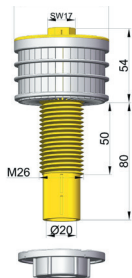

Type:H1206-B



材质 (Material) : PP
 缝隙 (Slots) : 0.2/0.5mm

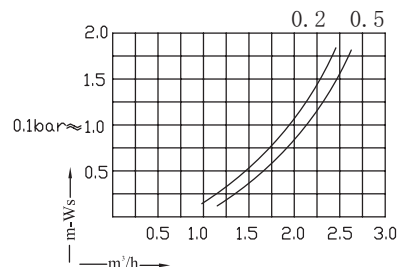
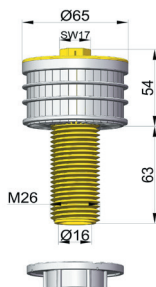

Type: H1206-B2



材质 (Material): PP
 缝隙 (Slots): 0.2/0.5mm

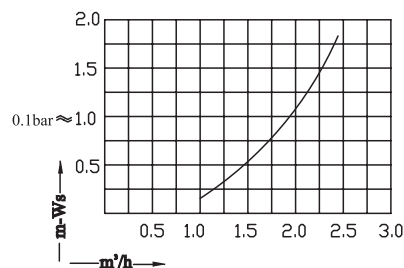
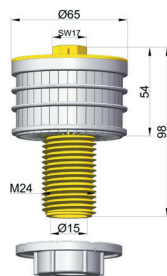

Type: H1206-E



材质 (Material): PP
 缝隙 (Slots): 0.2/0.5mm

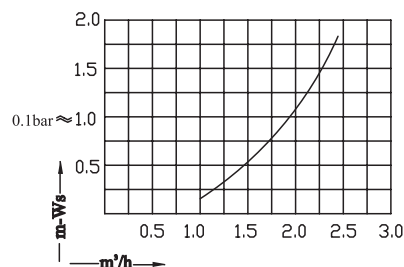
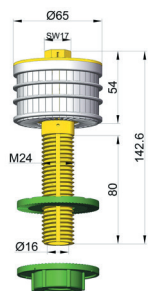

Type: H1207

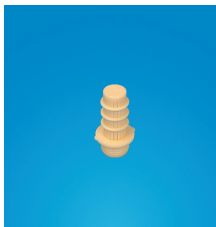

材质 (Material): ABS
 缝隙 (Slots): 0.2mm

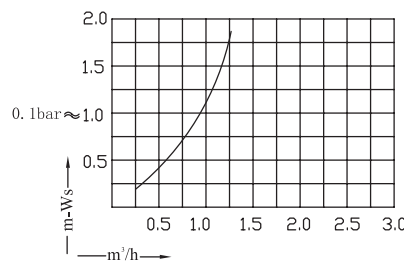
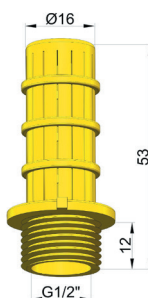

H1209-A H1209-B

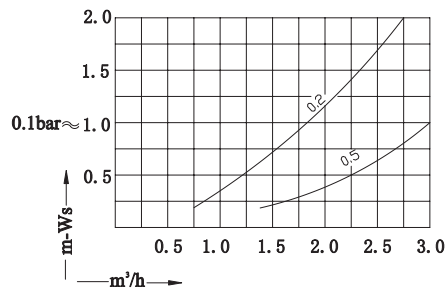
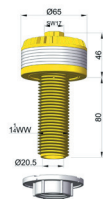

材质 (Material) : PP 缝隙 (Slots) : 0.2/0.5mm

H1209-AL H1209-BL

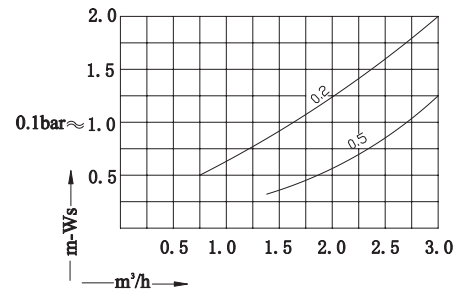
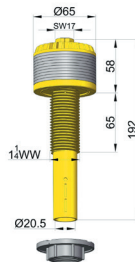

材质 (Material) : PP 缝隙 (Slots) : 0.2/0.5mm

H1202-K H1202-G



材质 (Material): PP
缝隙 (Slots): 0.2/0.35mm

H1206-K H1206-G

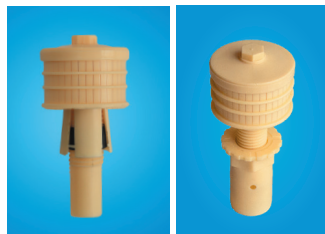

材质 (Material): PP
缝隙 (Slots): 0.2/0.5mm

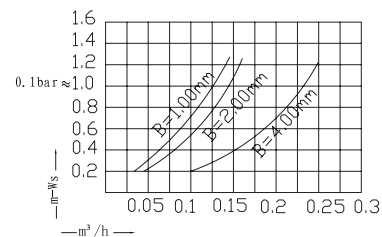
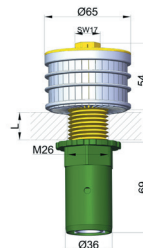
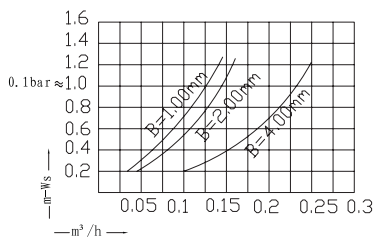
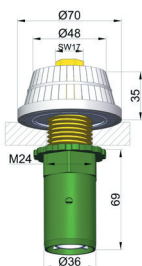
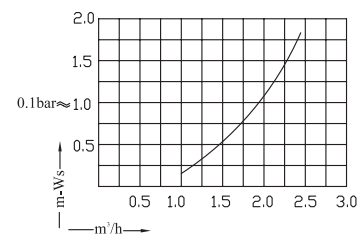
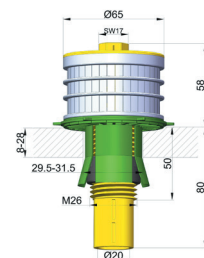
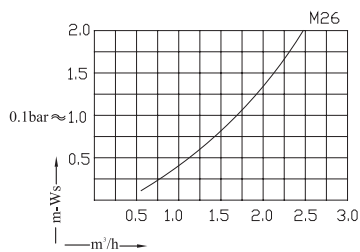
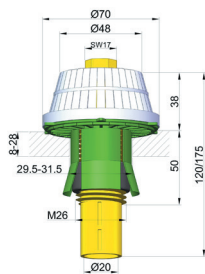

Type: H1204-A



$20 \leq L \leq 60$

材质 (Material): PP
 缝隙 (Slots): 0.2mm

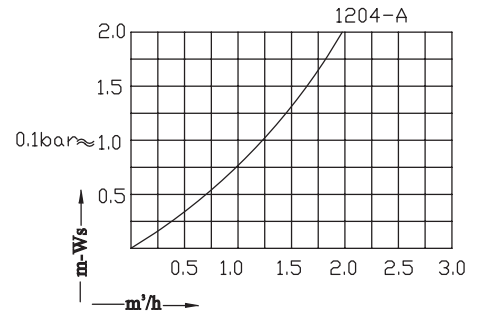
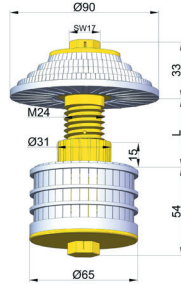

Type: H1204-B



$15 \leq L \leq 60$

材质 (Material): ABS
 缝隙 (Slots): 0.3mm

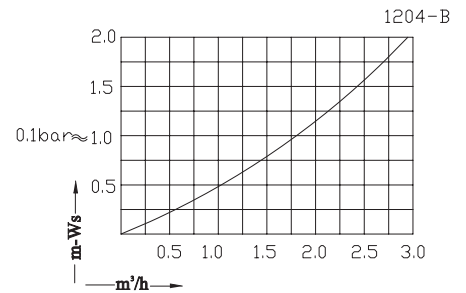
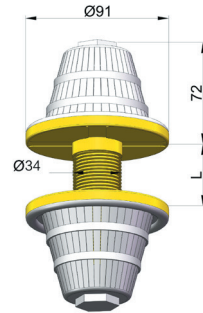

H1204-C



$15 \leq L \leq 50$

材质 (Material): PP
 缝隙 (Slots): 0.2/0.5mm

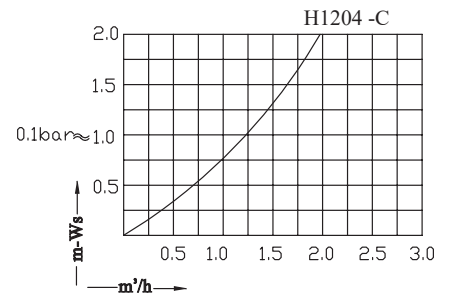
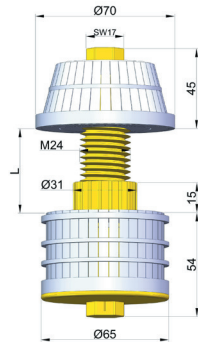

H1204-D



$20 \leq L \leq 60$

材质 (Material): PP
 缝隙 (Slots): 0.2/0.5mm

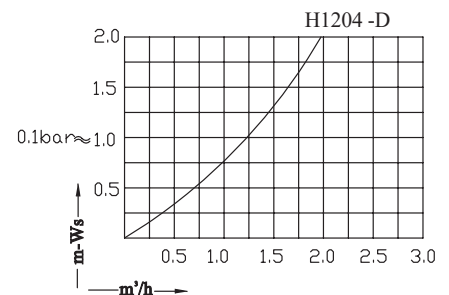
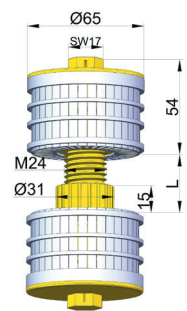

H1204-E



材质 (Material): PP
 缝隙 (Slots): 0.2/0.5mm

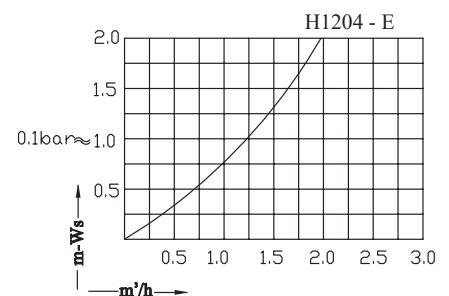
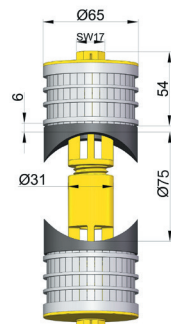

特殊环境适用

Type: H6-53



材质 (Material) : PPGV30S/PVDF
缝隙 (Slots) : 0.2mm

Type: H8-53



材质 (Material) : PPGV30S/PVDF
缝隙 (Slots) : 0.2mm

弱酸碱液体或者温度不超过110℃的高温液体，我们建议采用PPGV30S。

For hot water of a continuous temperature of up to max. 110 °C depending on the drop in pressure we recommend polypropylene with chemically combined PPGV30S.

强酸碱液体或温度在110℃—135℃的高温液体，我们建议采用PVDF。

For hot water of a continuous temperature of up to max.135 °C depending on the drop in pressure we recommend PVDF.

Type: H53-1, H53-2, H53-3

Type: H85

Type: H135

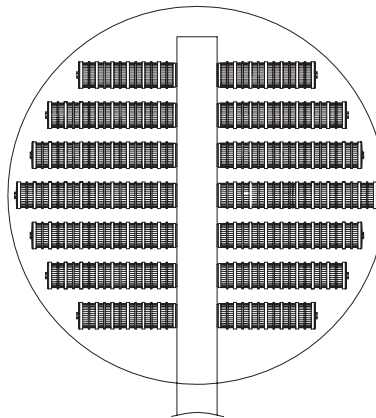
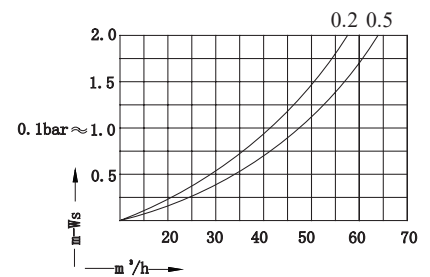
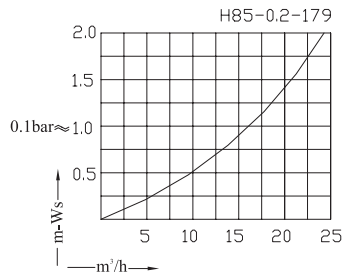
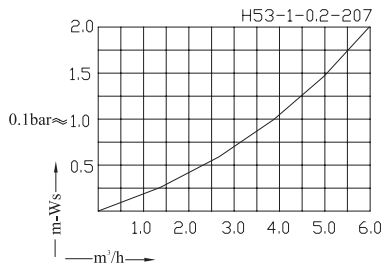
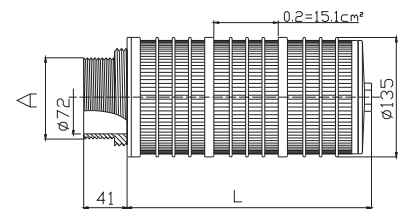
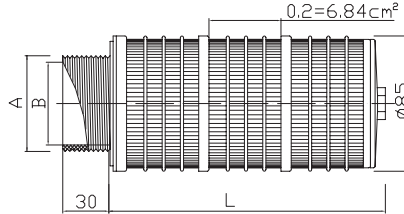
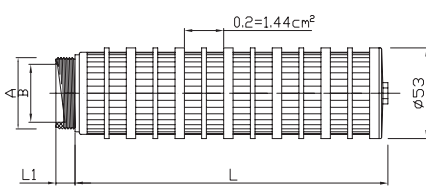
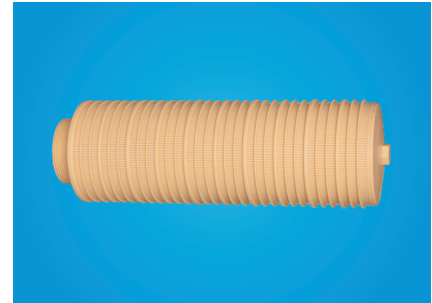
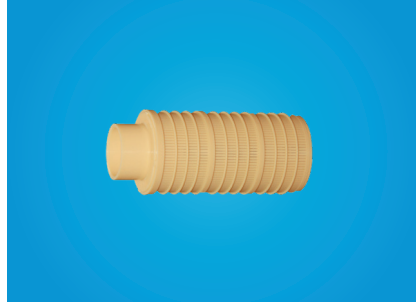

- V42
- V60
- V80
- V100
- H53
- H85
- H135

型号 (Type)	A(mm)	B(mm)	L1(mm)	缝隙Slots(mm)	材质Material	L2(mm)
H53-1	G 1¼"	21	22	0.2	PPGV30S PVDF	207,271,303,335,+32...
H53-2	1"NPT/G1"	21	17			111,175,207,239,+32...
H53-3	¾"NPT	18.5	17			111,175,207,239,+32...
H85	2"PT/2"NPT/G2"	50	30			73,126,179,232,285,+53...
	1.5"NPT/G1.5"	37	30			
H135	3"NPT/3"BSPT	72	41	PVDF	173,248,323,398,473,+75..	

Type: H65-80



材质 (Material) : PPGV30S/PVDF
 缝隙 (Slots) : 0.2mm

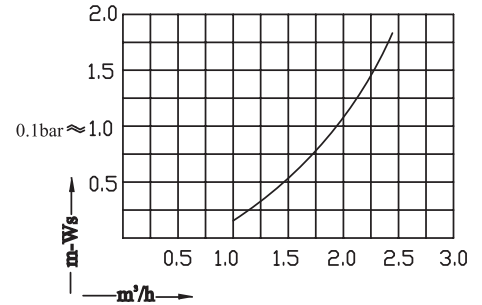
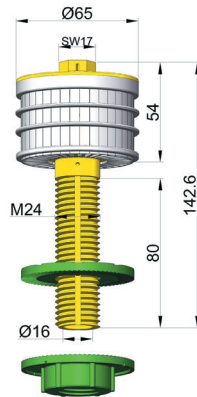

Type: HD65



材质 (Material) : PPGV30S/PVDF
 缝隙 (Slots) : 0.2mm

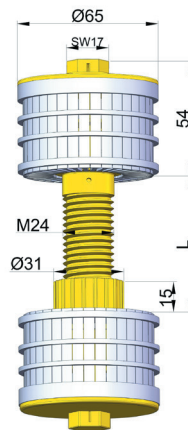

$20 \leq L \leq 60$

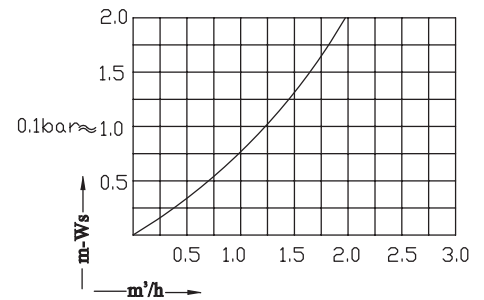

Type: HG65



材质 (Material) : PPGV30S/PVDF
 缝隙 (Slots) : 0.2mm

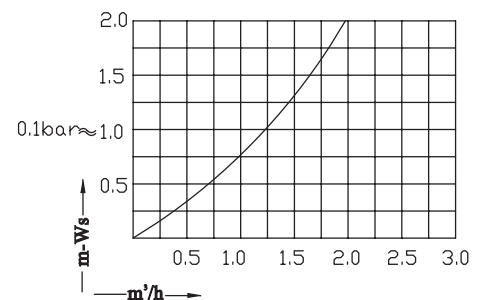
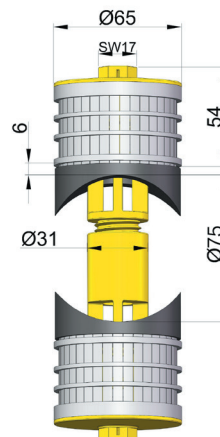

Type: H1201-AS

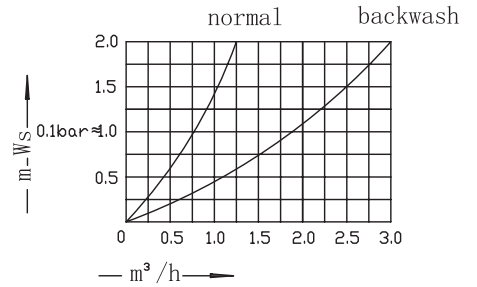
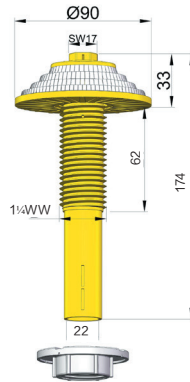

材质 (Material) : PVDF
 缝隙 (Slots) : 0.2mm

Type: H1202-1S

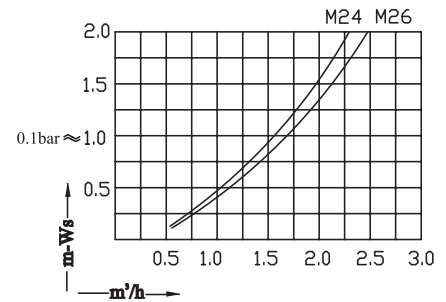
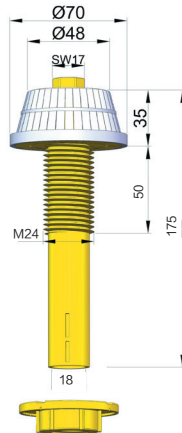

材质 (Material) : PVDF
 缝隙 (Slots) : 0.2mm

Type: H1209-BLS

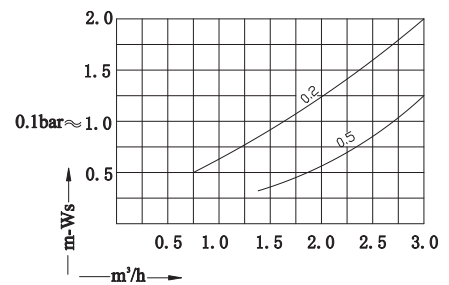
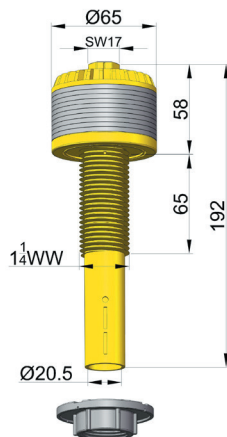

材质 (Material) : PPGV30S/PVDF
 缝隙 (Slots) : 0.2mm

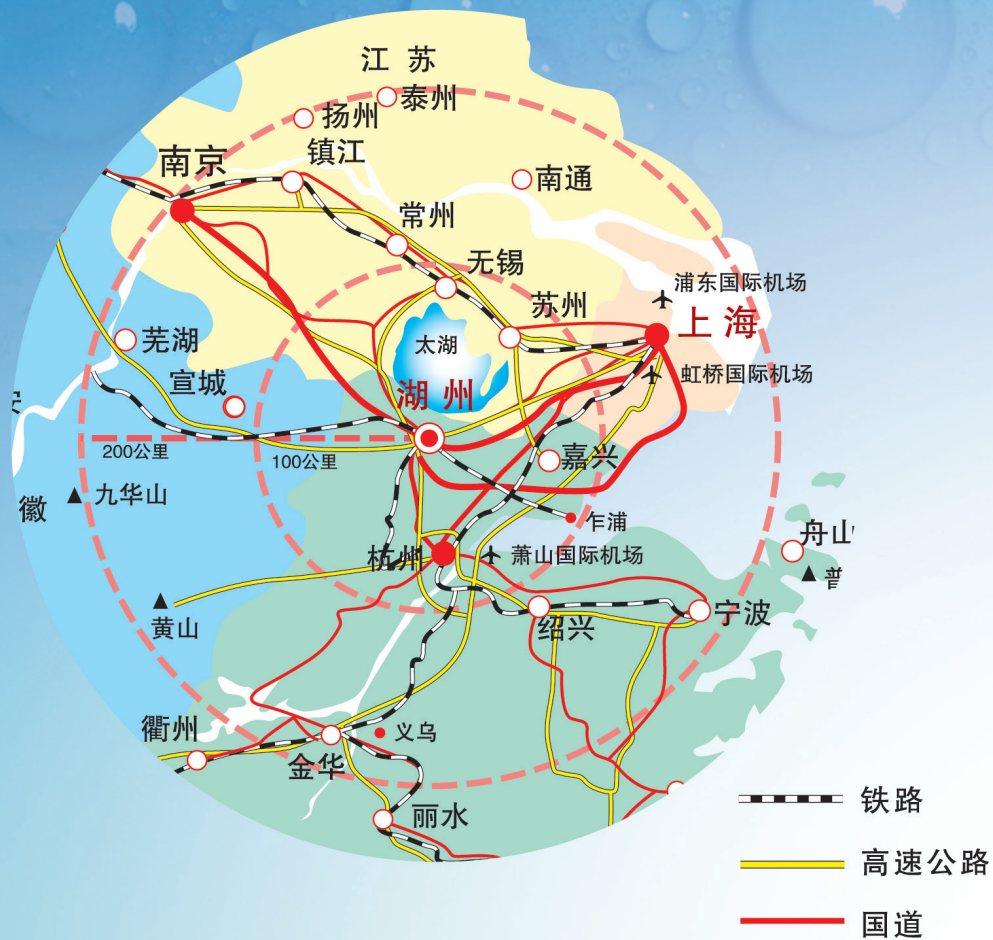

湖州恒鑫过滤科技有限公司

HuZhou HengXin Filter Technology Co., Ltd

地址: 浙江省湖州市八里店工业园区

(Add): Bailidian Industrial Zone, Huzhou, Zhejiang, China

电话 (Tel): 86-572-2812276 (国内销售)

86-572-2812278 (foreign trade department)

传真 (Fax): 86-572-2812277

Http://www.hxplastics.com

E-mail: info@hxplastics.com (国内销售)

jessica@hxplastics.com (foreign trade department)



企业微信公众号